

MODEL VSC85-17

17 CUBIC FOOT ULTRA LOW TEMPERATURE FREEZER

	WIDTH	DEPTH	HEIGHT	WIDTH	DEPTH	HEIGHT
INTERIOR DIMENSIONS	69 IN	20 IN	21 IN	175 CM	50 CM	53 CM
EXTERIOR DIMENSIONS	81.25 IN	33.5 IN	48.5 IN	206 CM	85 CM	123 CM
CRATED DIMENSIONS	84 IN	42 IN	58 IN	213 CM	104 CM	147 CM

NOTE THAT THE FREEZER LID CAN OPEN UP TO APPROXIMATELY 75° FROM HORIZONTAL POSITION

SIDE VIEW

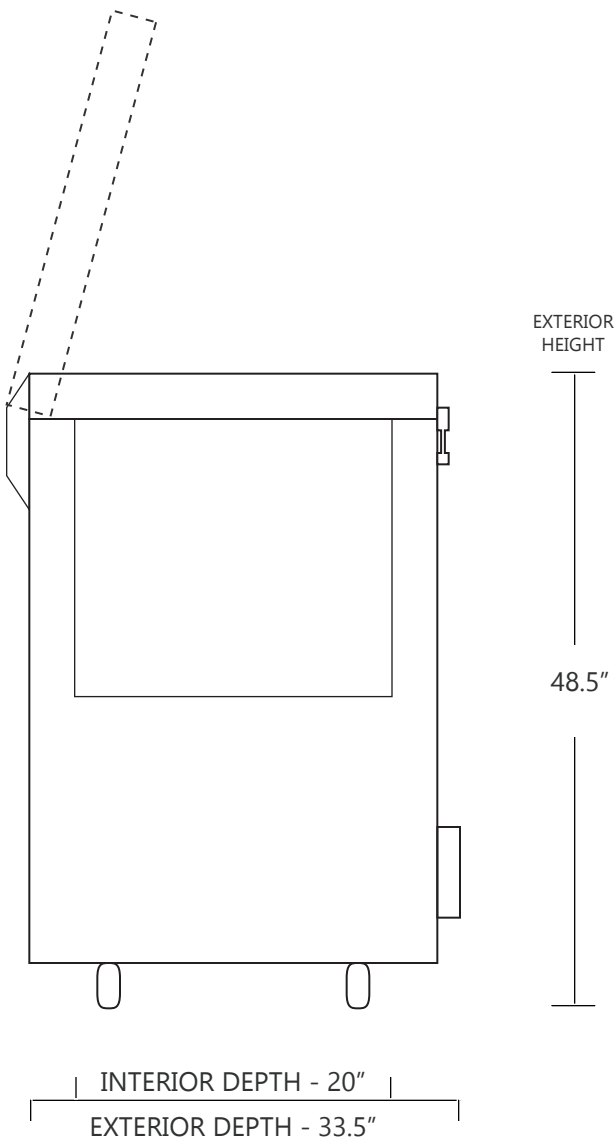

FRONT VIEW

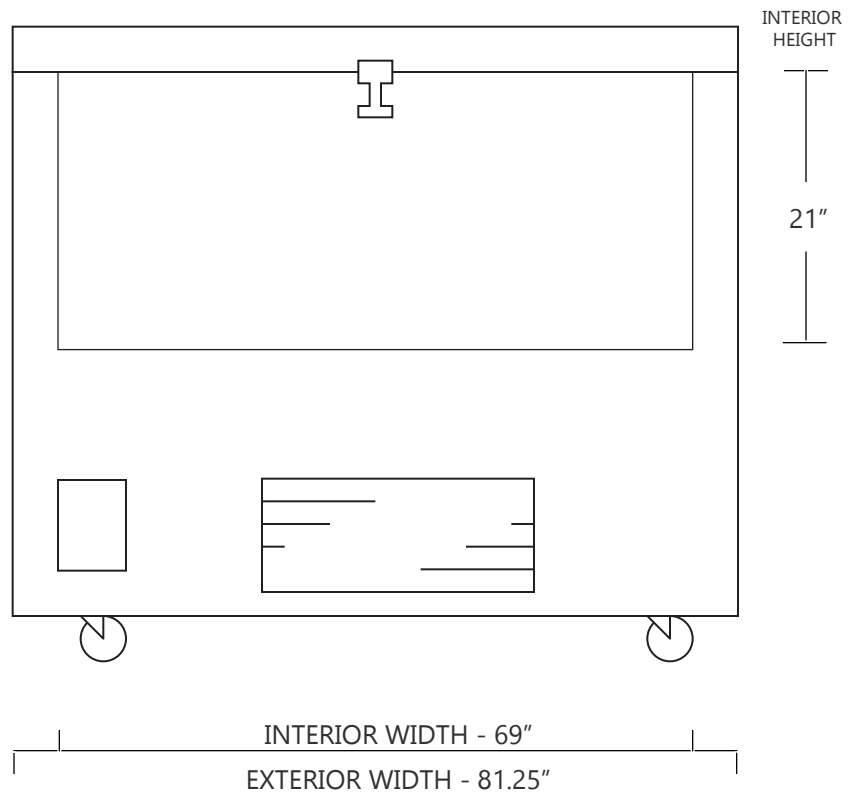

SO-LOW

WWW.SO-LOW.COM



NET WEIGHT : 775 LBS.
SHIPPING WEIGHT: 975 LBS.

SHIPPING OPTIONS

DOCK-TO-DOCK DELIVERY (REQUIRES FORKLIFT OR PALLET JACK)
DOCK-TO-DOCK DELIVERY WITH LIFTGATE (REQUIRES FORKLIFT OR PALLET JACK)
INSIDE DELIVERY (WHITE GLOVE DELIVERY)