

MODEL VSC85-14

14 CUBIC FOOT ULTRA LOW TEMPERATURE FREEZER

	WIDTH	DEPTH	HEIGHT	WIDTH	DEPTH	HEIGHT
INTERIOR DIMENSIONS	62 IN	20 IN	20 IN	157 CM	50 CM	50 CM
EXTERIOR DIMENSIONS	72.5 IN	33 IN	47.5 IN	184 CM	83 CM	120 CM
CRATED DIMENSIONS	77 IN	42 IN	55 IN	203 CM	109 CM	144 CM

NOTE THAT THE FREEZER LID CAN OPEN UP TO APPROXIMATELY 75° FROM HORIZONTAL POSITION

SIDE VIEW

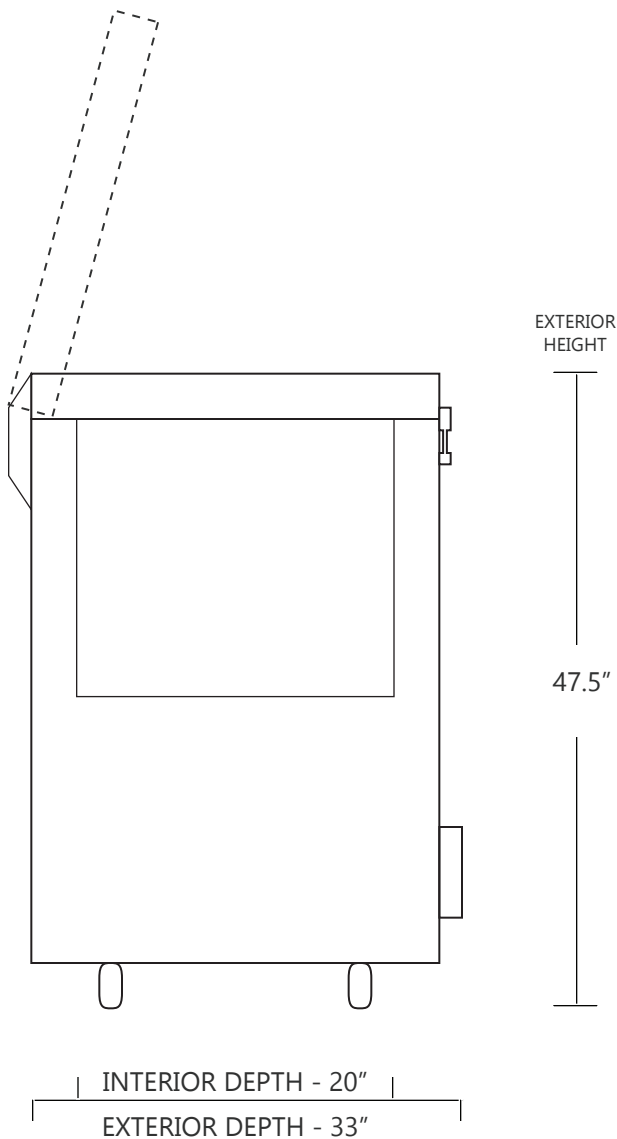

FRONT VIEW

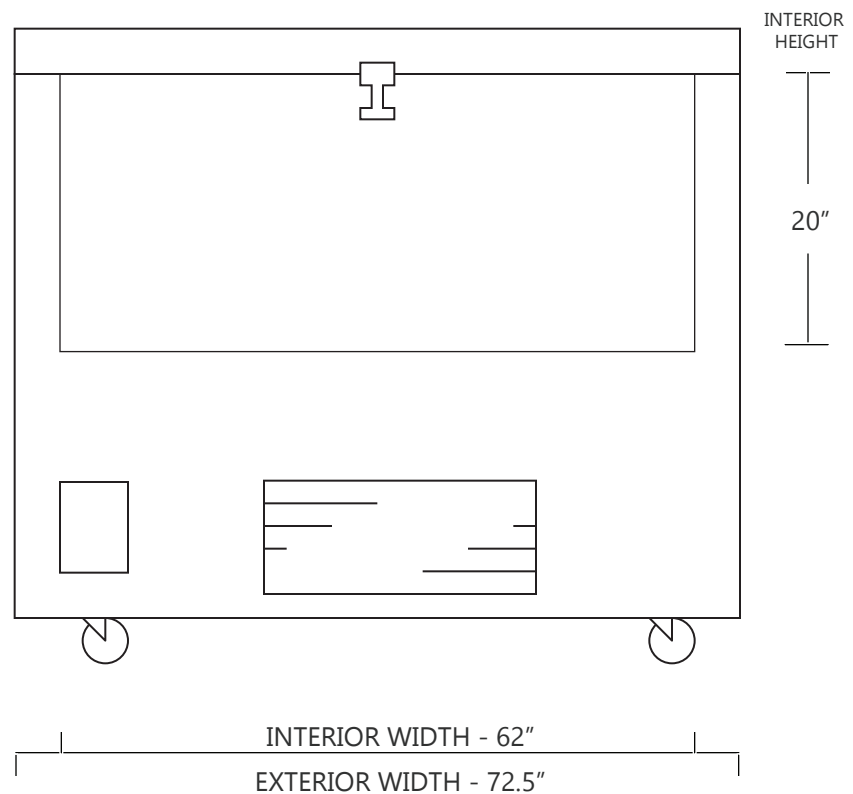

SO-LOW

WWW.SO-LOW.COM



NET WEIGHT : 725 LBS.
SHIPPING WEIGHT: 900 LBS.

SHIPPING OPTIONS

DOCK-TO-DOCK DELIVERY (REQUIRES FORKLIFT OR PALLET JACK)
DOCK-TO-DOCK DELIVERY WITH LIFTGATE (REQUIRES FORKLIFT OR PALLET JACK)
INSIDE DELIVERY (WHITE GLOVE DELIVERY)